

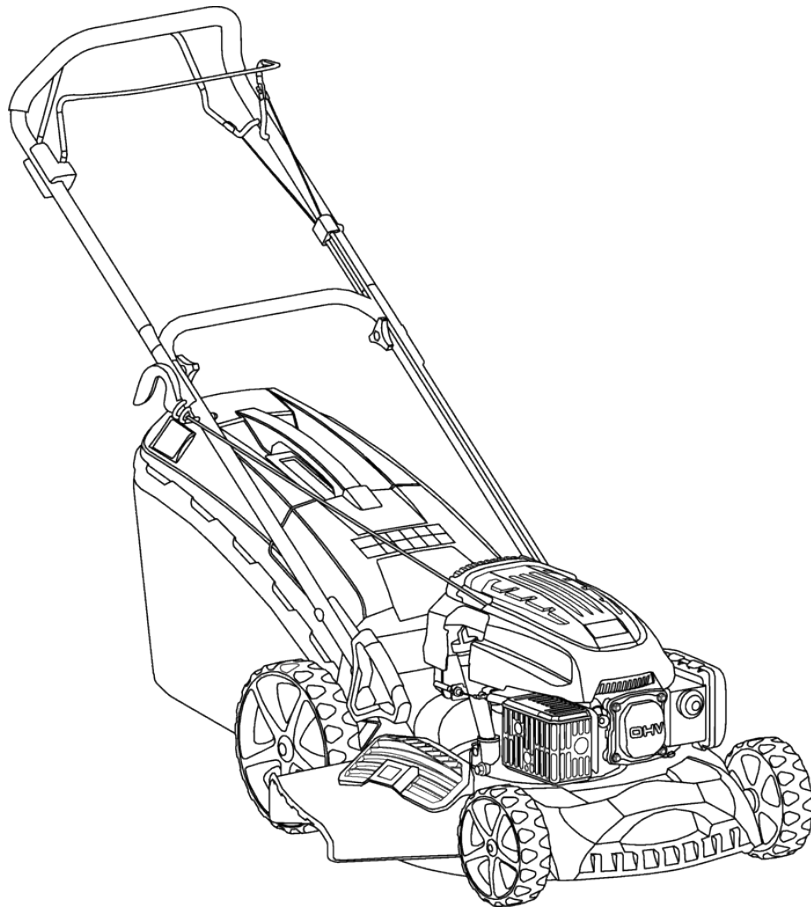

POSITION ONE POWER EQUIPMENT

P1 Petrol Lawn Mower **P4600SP**

User Manual



Introduction



Thank You For Purchasing Your P1 Lawnmower

We work very hard to give all of our customers the best possible service. If you have any problems, before leaving negative feedback, please contact us to give us a chance to resolve the issue.

**We would be delighted if you left us positive feedback!
Thank you for purchasing this product.**

This manual should be kept with the product. Please read and understand these instructions before you use your product. Failure to do this may result in personal injury or damage to the product.

The safety precautions and warnings are to ensure your safety and protect you from harm or damage to the product.

The information contained in this manual was accurate at the time of production, however P1 Power Equipment may make modifications to the product without notification.

GENPOWER LTD
Isaac Way, London Road,
Pembroke Dock, UNITED KINGDOM, SA72 4RW
T: +44 (0) 1646 687 880 F: +44 (0) 1646 686 198
www.p1pe.co.uk

Contents

Features.....	4
What's In The Box.....	4
Symbols On The Machine.....	5
General Safety.....	6-9
For Safe Operation.....	10-11
Getting To Know The Machine.....	12
Assembly.....	13-19
Cable Attachment.....	17
OPC Cable Adjustment.....	18
Before Each Use.....	20
Starting The Lawnmower.....	21-22
After Each Use.....	23
Stopping The Lawnmower.....	23
Checking Oil Level.....	16
Filling The Fuel Tank.....	16
Specifications.....	24
Troubleshooting.....	35
Maintenance And Care.....	26-37
Spare Parts.....	38
Tips For Mowing.....	39
Useful Information.....	40
Notes.....	41
Contact Us.....	42
Declaration Of Conformity.....	43

Features

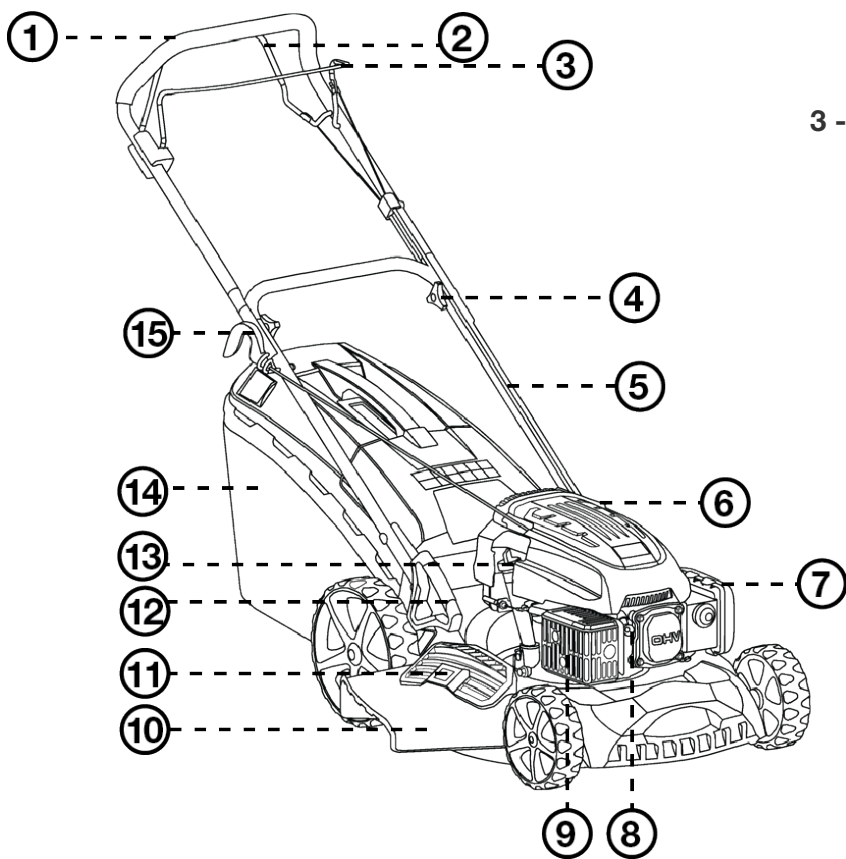

- 1 - Upper Handle
- 2 - Self-Propelled Drive Handle
- 3 - OPC (Operator Presence Control) Lever
- 4 - Handle Quick Release
- 5 - Lower Handle
- 6 - Fuel Filler Cap
- 7 - Air Filter
- 8 - Spark Plug
- 9 - Exhaust
- 10 - Side Discharge Chute
- 11 - Side Discharge Cover
- 12 - Wheel Height Adjustment Lever
- 13 - Oil Filler / Dipstick
- 14 - Grass Collector
- 15 - Recoil start Handle

What's In The Box

- P4600SP Lawnmower
- Grass Collector
- Assembly Tools
- User Manual

Symbols On The Machine



CAUTION!

Handle carefully.



INSTRUCTION MANUAL

Read and understand operator's manual before using the machine. Failure to follow instructions could result in death or serious injury.



DANGER!

Keep hands and feet away from cutting parts.



BEWARE OF SHARP BLADES

Remove the spark plug cable from the spark plug and always disconnect the machine from the mains before commencing maintenance work or if the cable is damaged. Always read instructions before carrying out any repair or maintenance.



DANGER AREA

Keep away from the danger area.



DANGER OF THROWN OBJECTS

Keep all bystanders and animals at least 15 metres away from the machine during operation. If approached, stop the machine immediately.



WARNING

Do not touch the rotating parts.



WARNING

Always use correct tools and original spare parts.



WARNING

Stop the engine before cleaning of work area.



KEEP BYSTANDERS AWAY

Keep bystanders, especially children away!



WARNING

The blade is sharp, do not touch the blade.



DO NOT USE ON SLOPES

Do not use on hills above 20°.



PROTECT FROM MOISTURE

Do not expose the product to rain or wet conditions.



WEEE SYMBOL

Waste electrical products should not be disposed of with household waste. Please recycle where facilities exist. Check with your local authority or local store for recycling advice.



PROTECTION CLASS II

Equipped with enhanced or double insulation.



CE SYMBOL

This product complies with the applicable European directives and an evaluation method of conformity for these directives was done.

General Safety



! WARNING : READ THE INSTRUCTION BOOKLET THOROUGHLY BEFORE USING THE MACHINE. Keep for future reference and pass it on if the machine is loaned or sold to another user.

Training

! DANGER !

Engine exhaust fumes contain Carbon Monoxide. This is a poisonous gas and can kill in minutes. NEVER use inside a building or in an area with poor ventilation.

! 1. WARNING! You must read these instructions carefully before operating the machine. Make sure that you are familiar with the controls and properly operate the machine. You must learn how to stop the engine quickly. If you do not follow the warnings and instructions, it may result in fire and/or serious injury. Make sure to save all warnings and instructions for future reference.

2. Never allow children or people unfamiliar with these instructions to use the product. Local regulations can restrict the minimum age of the operator.

3. Never operate while people, especially children, or pets are nearby.

4. Never operate the lawnmower if the user is unwell or tired, or has taken alcohol, medicine, drugs or any substances which may slow the user's reflexes and compromise judgement.

5. Keep in mind that the operator or user is responsible for accidents, hazards or unexpected events involving the machine that occur to other people or their property. It is the responsibility of the user to assess the potential risk of the area where work is being

carried out. The operator or user must take all necessary precautions to ensure their own safety and that of others, especially on slopes or rough, slippery and unstable ground.

6. If the lawnmower is sold or lent to others, you must make sure that the operator reads this manual. Keep this manual safe and pass it on to the new user.

Preliminary Operations

1. Always wear anti-slip and resistant work footwear and long pants while using the machine. Do not use the lawnmower when barefoot or wearing open sandals. Do not wear chains, bracelets or clothing that is loose fitting or hanging ties or cords. Tie long hair back. Always wear protective earplugs.

2. Make sure you thoroughly inspect the entire work area and remove all objects and anything that could be thrown by the machine or could damage the engine or cutting unit (branches, stones, wire, toys, etc).

! 3. WARNING: DANGER! Petrol is highly flammable.

- Make sure to store the fuel in special containers.

- Use a funnel to add fuel, only outdoors. Do not smoke during this and each time fuel is handled.

- Add fuel before igniting the engine, never remove the fuel tank cap or add fuel whilst the engine is running or when it is hot.

- If you have spilled fuel, make sure you do not attempt to ignite the engine but move the

General Safety

machine away from the area of spilled fuel e and avoid creating any source of ignition until the fuel has evaporated and fuel vapours have dissipated.

- Make sure to always put the tank and fuel container caps back on and tighten well.

4. Make sure to replace faulty silencers.

5. You must check the general condition of the machine before using and in particular:

- Check that the screws and cutting unit are not worn or damaged and check the appearance of the blade. Replace the entire blade and all worn or damaged screws to preserve balance. Any repairs must be done at a specialised centre.

- Do not force the safety lever as it must move freely; it should return automatically and quickly back to the neutral position, resulting in the stopping of the blade.

6. Where applicable, check the battery status regularly. If there is any damage to the casing, cover or terminals, you must replace it.

7. Before you start work, always fit the exit guards (grass collector, side discharge guard or rear discharge guard).

 **8. WARNING** - The noise and vibration levels shown in these instructions are the maximum levels for use of the lawnmower.

The use of an unbalanced blade, the excessive speed of movement, or the absence of maintenance have a significant influence on noise emissions and vibrations. It is necessary to take preventive steps to eliminate possible damage due to high levels of noise and stress from vibration. You must maintain the machine well, wear ear protection and take breaks from working.

Appropriate Personal Protective Equipment (PPE), **MUST** be worn at all times when operating or repairing the machine.



GLOVES

Protective electrically non-conductive gloves are highly recommended when working.



BOOTS

Non-skid heavy duty footwear are highly recommended when working.



HEARING PROTECTION

Suitable safety hearing protection is recommended.



EYE PROTECTION

Always wear safety glasses/goggles and/or face shields. Everyday eyeglasses have only impact resistant lenses; they are not safety glasses/goggles.



CLOTHING

Do not wear loose clothing, gloves, scarfs, neckties or jewellery (rings, wrist watches), which can be caught in moving parts.

General Safety



General Fuel Safety



CAUTION! ALL FUELS ARE FLAMMABLE

- Fire hazard - keep fuel away from all sources of ignition for example heaters, lamps, sparks from grinding or welding.
- DO NOT carry out hot work on tanks that have contained fuel.
- ALWAYS keep the work area tidy.
- ALWAYS clean up spills promptly using absorbent granules and a lidded bin.
- ALWAYS dispose of waste fuels correctly.



Fueling / De-Fueling



CAUTION! ALL FUELS ARE FLAMMABLE

- ALWAYS fuel and de-fuel in a well ventilated area outside of buildings.
- ALWAYS wear correct, suitable and fit for purpose Personal Protective Equipment (PPE), suggested items are but not limited to safety gloves, overalls.
- When fueling/de-fueling ALWAYS avoid inhaling fumes.
- When de-fueling ALWAYS use a proper fuel retriever.
- ALWAYS carry fuel in the correct and clearly marked container.



Electrical Safety (Where Applicable)

- Electricity can kill – NEVER work on LIVE/ENERGISED equipment.
- Prior to carrying out any maintenance work you MUST identify electrical isolation methods and isolate all electrical supplies.
- Prior to use and with all electrical supplies isolated, you MUST check all electrical cables, plugs and connectors for the following;
 - Are intact and have no signs of damage, to include but not limited to bare wires, chaffing, cuts and loose wiring.
 - If there are any signs of damage, the damaged item MUST be taken out of service until the damage has been repaired by an electrically competent person.
- All trailing cables should be routed so as not to cause any kind of trip hazard.
- NEVER work on or near electricity with wet hands, wet clothing and wet gloves.

Batteries (Where Present)

Batteries present a risk if they become damaged by the possible leaking of electrolyte. This electrolyte is an acid and can cause serious burn injuries. Care should be taken when working on or near them. **NOTE** the electrolyte may be in a liquid or gel form.

Should you come in to contact with electrolyte you should;

- Remove all clothing contaminated with electrolyte. If you cannot remove then saturate them in water.
- Get medical assistance as soon as possible.

General Safety

You must advise the medical staff of the type of acid.

- Lead/acid battery = dilute sulphuric acid.
- Nickel/cadmium = potassium hydroxide alkali electrolyte.
- Use fresh running water to wash off excess electrolyte, continue this until medical assistance arrives. Make sure that you do not wash the electrolyte to another part of your body or face.
- If electrolyte comes in to contact with Eyes the electrolyte needs to be immediately washed away with large amounts of water. Make sure that you do not wash the electrolyte to another part of your face or body.
- Gasses from charging batteries are highly flammable and great care should be taken to charge in well ventilated areas.



- There is an explosion risk if the battery terminals are short circuited, when connecting/disconnecting ALWAYS exercise great care so that the terminals or battery leads are NOT allowed to touch and cause a spark. ALWAYS use suitable insulated tools.

Vibrations (Where Applicable)

- Prolonged use of hand held (operated) machines will cause the user to feel the effects of/from vibrations. These vibrations can lead to white finger (Raynaud's phenomenon) or carpal tunnel syndrome. This condition reduces the ability of the hand to feel and regulate temperature, causing numbness and heat sensations and may cause nerve damage and circulatory tissue death.
- Not all factors that lead to white finger disease are known, but cold weather, smoking

and other diseases that affect blood vessels and blood circulation as well as large and long-lasting impact of shocks are considered factors in the formation of white finger. Note the following to reduce the risk of white finger and carpal tunnel syndrome;

- Wear gloves and keep your hands warm.
- Take regular breaks.
- All of the above precautions may help reduce the risk of white finger disease but not rule out the carpal tunnel syndrome. Long-term and regular users are therefore recommended to observe the condition of your hands and fingers. Seek medical attention immediately if any of the above symptoms should occur.

Noise (Where Applicable)

- The operating noise of the machine can damage your hearing. Wear hearing protection such as earplugs or ear defenders to protect your hearing. Long-term and regular users are advised to have hearing checked regularly. Be especially vigilant and cautious when wearing ear protection because your ability to hear alarm warnings will be reduced.
- Noise emissions for this equipment is unavoidable. Carry out noisy work at approved times and for certain periods. Limit the working time to a minimum. For your personal protection and protection of people working nearby it is also advisable for them to wear hearing protection.



- See Certificate of Conformity section for Outdoor Noise declaration of conformity.

For Safe Operation

During Use

 **1.** Never operate the engine in a confined space where dangerous carbon monoxide fumes can develop. All ignition operations have to be effected in an open or well-ventilated area. Always remember that exhaust fumes are toxic.

Carbon monoxide is a colourless and odourless gas. Inhaling this gas can cause death as well as serious long term health problems such as brain damage.

The symptoms of carbon monoxide poisoning can include but are not limited to the following; Headaches, dizziness, nausea, breathlessness, collapsing or loss of consciousness.

Carbon monoxide poisoning symptoms are similar to flu, food poisoning, viral infections and simply tiredness. It is quite common for people to mistake this very dangerous poisoning for something else.

To avoid carbon monoxide poisoning **DO NOT** use Petrol/Diesel powered equipment inside any of the following; Home, garage, tent, camper van, mobile home, caravan or boat. This is not exhaustive and if you are in any doubt contact your dealer.

If you think you have or someone around you has been affected by carbon monoxide poisoning; Get them fresh air immediately, by leaving the affected area or by opening doors and windows. If safe and practical to do so make sure that the machine is turned off. **DO NOT** enter a room you suspect of having carbon monoxide present – instead call the emergency services.

Contact a Doctor immediately or go to Hospital – let them know that you suspect carbon monoxide poisoning.

DO NOT use in an enclosed area or moving vehicle.

- 2.** You must only work in daylight or with good artificial light in good visibility conditions. Keep people, children and animals away from the working area.
- 3.** Avoid mowing wet grass if possible. Do not work in the rain and when there is a thunderstorm or lightning risk. If there is bad weather conditions, do not use the machine.
- 4.** Make sure on slopes you have a steady foothold.
- 5.** Do not allow the lawnmower to pull you along, you must walk and never run.
- 6.** You must pay special attention when approaching obstacles that could compromise visibility.
- 7.** When mowing on slopes, you must mow across the slope and not up and down it. When changing direction, you need to be careful that the wheels do not hit any obstacles (such as roots, branches, stones, etc) that can cause the lawnmower to slide sideways or make you lose control of it.
- 8.** The lawnmower must never be used on slopes of over 20°, regardless of the mowing direction.
- 9.** Be very careful when pulling the lawnmower toward you. You must look behind you to make sure there are no obstacles before and during operations in reverse gear.
- 10.** You must immobilise the blade if the machine must be inclined for transport, when moving over surfaces other than grass and when the lawnmower is transported from or to an area that must be cut.
- 11.** When using the machine near roads, pay attention to traffic.
- 12.** Do not operate the machine with damaged guards or without the grass collector, side discharge guards or rear discharge guards.

For Safe Operation

13. You must be careful near ravines, ditches or embankments.

14. Follow the instructions to ignite the engine carefully whilst keeping feet away from the blade.

15. Never incline the lawnmower during ignition. Ignite the machine on a flat surface without obstacles or high grass.

16. Do not place your hands or feet near or under rotating parts. Keep away from the discharge opening.

17. If the lawnmower is running, do not lift or transport.

18. Do not tamper with or disable safety systems.

19. Do not over-rev the engine or change the engine settings.

20. The engine parts get very hot when running, do not touch. Danger of burns.

21. Disengage the wheel drive before igniting the engine on power-driven models.

22. Only use manufacturer-recommended attachments.

23. If the attachments/tools are not installed in their seats, do not use the machine.

24. You must disengage the blade, switch off the engine and unplug the spark plug cable (making sure that all moving parts are stationary):

- When transporting the machine
- Whenever you leave the machine unattended; also remove the key on models with electric ignition systems
- Before clearing blockages or unclogging the discharge chute
- Before cleaning, checking or working on the machine
- After striking a foreign object, you must

inspect the machine for damage and make repairs before using it again.

25. Disengage the blade and turn off the engine:

- Before refuelling
- Whenever you remove or attach the grass collector
- Whenever you remove or attach the side discharge chute
- Before adjusting the cutting height

26. Always keep a safe distance from the rotary blade, given by the length of the handle.

27. Before stopping the engine, reduce the throttle setting. Shut off the fuel supply on finishing the work, following the instructions in the manual.

28. Stop the engine before emptying the grass collector or before you change the cutting height.

 **29. WARNING** - If something breaks or an accident happens whilst working, you must turn off the engine immediately and move the lawnmower away to prevent further damage. If an accident happens with injuries or third parties are injured, carry out the first aid measures most suitable for the situation immediately and contact the medical authorities for any necessary health care. Carefully remove any debris that might cause damage or harm persons or animals should it not be seen.

30. Start the engine carefully according to instructions and with feet well away from the blade.

31. Do not tilt the lawnmower when starting the engine.

32. Do not tamper with the safety features.

General Safety

Getting To Know The Machine

Machine Description And Scope Of Application

The P4600SP is a petrol powered rotary lawnmower from P1 Power Equipment, ideally suited for medium to large sized lawns. The P4600SP has a cutting width of 460mm and is powered by a 139cc 4-stroke OHV petrol engine.

This machine is a garden tool and precisely a pedestrian controlled lawnmower. The machine is essentially composed of an engine which drives a blade enclosed in a casing, equipped with wheels and a handle. The operator is able to operate the machine and use the main controls, always staying behind the handle at a safe distance from the rotating blade. If the operator leaves the machine, the engine and cutting means will stop within a few seconds.

The lawnmower is manufactured according to the latest safety requirements. These include a blade brake that stops the engine and blade in when you let go of the OPC lever. Every precaution is only effective when it is followed exactly.

Intended Use

This machine was designed and manufactured for cutting (and collecting) grass in gardens and grassy areas, in areas in proportion to its cutting capacity, done by a pedestrian operator.

The presence of attachments or specific devices can prevent cut grass from being collected or produce a mulching effect, depositing cut grass on the ground.

User Types

This machine is intended for use by consumers, i.e. non-professional operators. The machine is intended for "DIY" and domestic use only.

Improper Use

Any other usage not in keeping with the above mentioned ones may be hazardous and harm persons and/or damage things. Examples of improper use may include, but are not limited to:

- transporting people, children or animals on the lawnmower
- letting yourself be transported by the lawnmower
- using the machine to tow or push loads
- using the machine for leaf or debris collection

- using the machine to trim hedges, or cutting anything other than grass
- use of the machine by more than one person
- using the blade on surfaces other than grass

Assembly

Getting Started

⚠ CAUTION - This guide is meant to serve as a quick reference for operating your HYUNDAI lawnmower. We always advise reading the manual in full before operation.

⚠ CAUTION - For OUTDOOR use ONLY. Petrol lawnmowers produce carbon monoxide – a poisonous, colourless and odourless gas that can cause serious injury or death. Petrol is highly flammable, always handle with extreme care and in a well ventilated area.

⚠ NOTE - Images may vary depending on model. If the lawnmower has the mulching option, the mulching plug may already be installed for transport.

⚠ NOTE - The lawnmower can be supplied with some parts already assembled. Prior to assembly, check all items have been received.

⚠ WARNING - Unboxing and assembling the lawnmower should be done on a flat, stable surface with enough room. Disposal of the packaging should be done in accordance with the local regulations in force.

⚠ NOTE - The lawnmower is shipped without oil or petrol. You MUST ensure the correct oil and fuel is used BEFORE use.

Unboxing & Assembly Video:

Go to [youtube.com](https://www.youtube.com) and type in P4600SP petrol lawnmower unboxing & assembly.

YOU MUST read and understand the instruction manual first.

As soon as you have purchased your machine, we recommend that you fill out the information on page 42. If you need to contact an authorised dealer or customer service for information on servicing, you may need to provide this information. There is also a service record so you can keep track of your lawnmower service dates.

STEP 1



Attach the lower handle to the deck of the mower by inserting the bolt.

STEP 2



Place the plastic over the bolt washer ensuring the curve of the washer sits on the curve on the handle bar.

STEP 3



Secure in place using the large locking wheel.

Assembly

STEP 4



Attach the upper handle to the lower handle by inserting the bolt.

STEP 5



Place the plastic over the bolt washer ensuring the curve of the washer sits on the curve on the handle bar.

STEP 6



Secure in place using the large locking wheel.

STEP 7



The handles should look like this.

STEP 8



Lift the rear discharge flap to expose the grass bag support bar.

STEP 9



Using the hooks on the grass bag, hook the grass bag over the bar at the rear of the lawn mower.

Assembly

STEP 10



Lower the rear discharge flap until it rests on the grass bag.

STEP 11

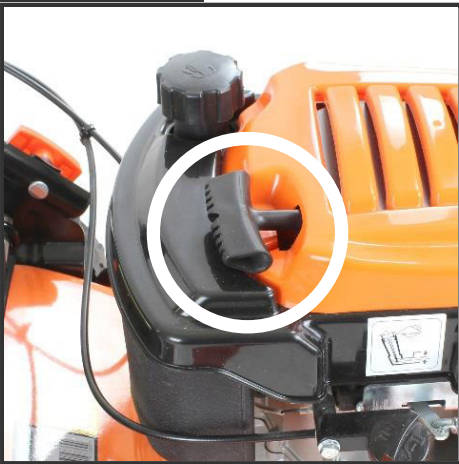

Gently pull the recoil start handle up to the recoil retaining loop.

STEP 12

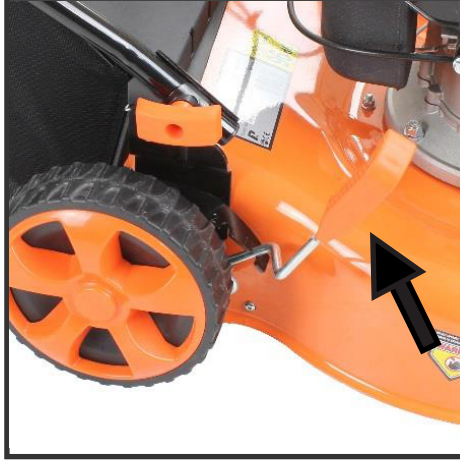

Set the cutting height to maximum.

STEP 13

Fill the lawnmower with oil and fuel. Instructions on how to do this are on the next page.

STEP 14

Make sure you attach the cables and adjust the OPC and drive cables. Instructions on how to do this are on pages 17, 18 and 19.

Assembly

Adding Oil

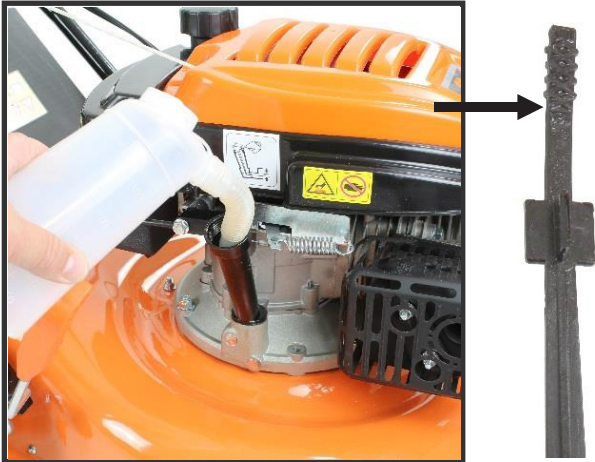

1. Place the lawn mower on a flat level surface and unscrew the dipstick.
2. Remove the oil filler cap and wipe the dipstick clean.
3. Refit the dipstick without screwing it down.
4. Remove the dipstick and check the oil level. It should be up to the upper mark on the dipstick. DO NOT overfill. The oil level should not be above the upper mark on the dipstick.
5. If the oil level is too low, add SAE 30 engine oil part number '600MLSAE30OIL' or 15W40 engine oil, to the upper mark on the dipstick (as shown above).
6. Once the correct amount of oil has been added, refit the dipstick securely.

If you do overfill, you can remove some oil by gently tilting the machine on its side and pouring the excess oil into a suitable container or use an oil syringe.

NOTE - All machines are tested and inspected so there may be some residual oil left in the machine so please fill with caution.

Adding Fuel



CAUTION - ALL FUELS ARE FLAMMABLE

ALWAYS fuel and defuel in a well ventilated area outside of buildings and away from any possible sources of ignition.

ALWAYS wear correct, suitable and fit for purpose Personal Protective Equipment (PPE). Suggested items are but not limited to, safety gloves, eye protection and overalls.

1. Place the lawn mower on a flat level surface and remove the fuel filler cap and slowly fill with unleaded petrol.
2. Fill the fuel tank with fresh straight unleaded petrol. DO NOT fill the tank right to the top but leave a 25mm gap between the top of the fuel tank and the fuel filler cap.
3. Refit the fuel filler cap securely and clean up any fuel spill before starting the engine.

DO NOT overfill. The fuel tank only needs to contain enough fuel to complete the days mowing. If you run out of fuel, refilling must only be done once the engine has cooled down. Fuel stored within the machine for 28 days or more can go stale and should be drained before further use.

Cable Attachment

Cable Attachment

NOTE - If you are stood behind the lawnmower:

OPC Cable: This attaches to the lever in front of the main handlebar and if followed, will attach to the engine.

STEP 1



Gently push the handle free from its locating hole on the main handlebar.

STEP 2

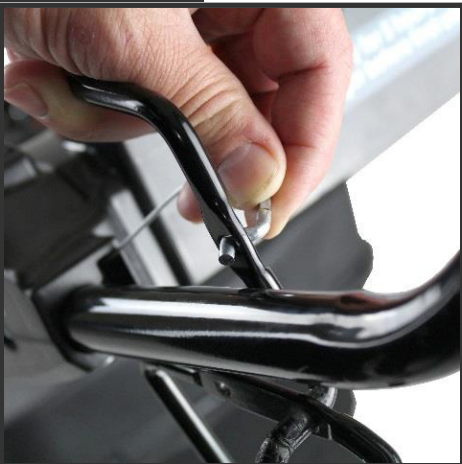

Insert the end of the cable in to the location hole on the lever.

STEP 3

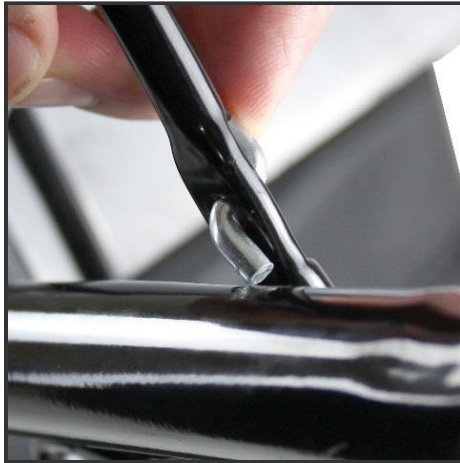

Follow the curve of the cable until the cable lies flat in the handle.

STEP 4



Refit the lever back into its location hole on the main handlebar. Check the cable lies flat and has not snagged on any other part of the lawn mower.

OPC Cable Adjustment

OPC Cable Adjustment

NOTE - It is necessary as part of routine maintenance to adjust the OPC cable tension to ensure the lawnmower will start correctly.

If there is more than 10mm movement in the OPC lever before the cable begins to move, then the OPC cable will require adjustment.

STEP 1

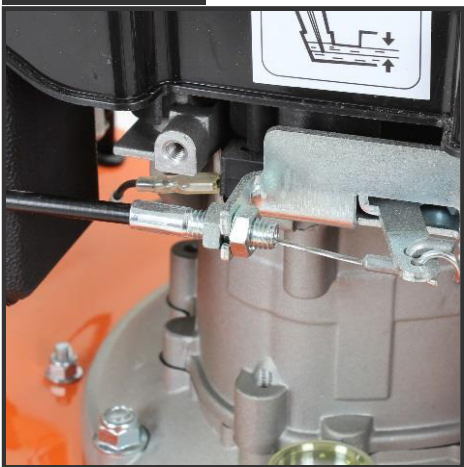

If adjustment is required, trace the OPC cable down from the handle to the engine of the lawn mower, until you reach the OPC cable adjuster.

STEP 2

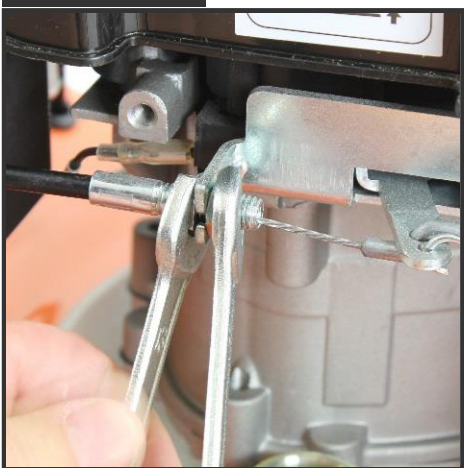

Undo the lock nut.

STEP 3

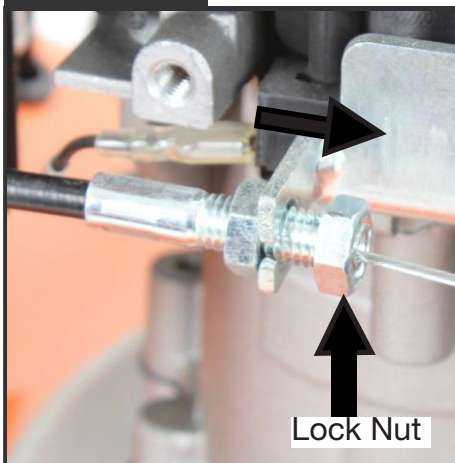

Wind it forwards.

STEP 4

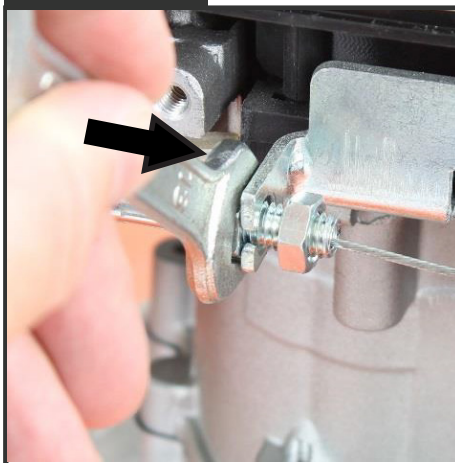

Wind the adjuster nut towards the lock nut. As you adjust, keep checking the tension on the OPC cable until the desired tension is reached.

STEP 4

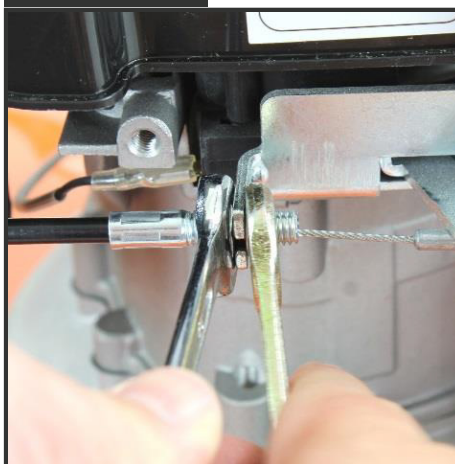

Tighten the lock nut back towards the adjuster nut then attempt to start the lawn mower. If the lawn mower starts, tighten both nut securely. If not, repeat the process until the lawn mower will start.

Drive Cable Adjustment

Drive Cable Adjustment

⚠ NOTE - It is necessary as part of routine maintenance to adjust the drive cable tension to ensure the lawnmower will self-propel correctly.

If there is more than 10mm movement in the drive lever before the cable begins to move, then the drive cable will require adjustment.

STEP 1



If adjustment is required, trace the drive cable down towards the gearbox of the lawn mower, until you reach to drive cable adjuster.

STEP 2

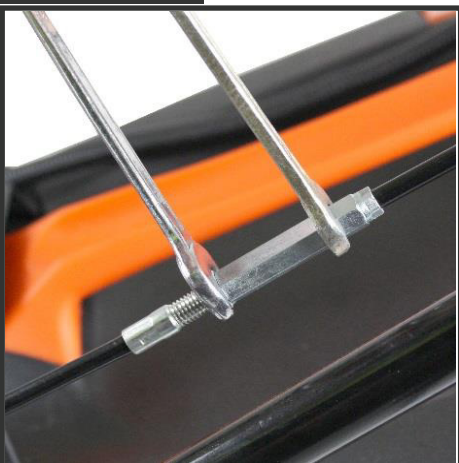

Undo the lock nut and wind away from the adjuster nut.

STEP 3

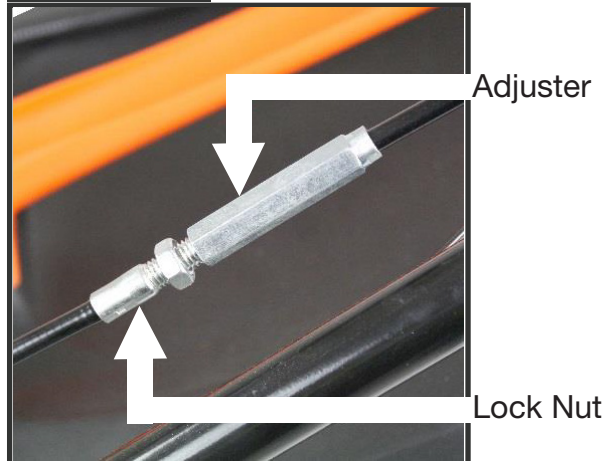

Undo the lock nut and wind away from the adjuster nut.

STEP 4



Wind the adjuster nut towards the main handlebar. As you adjust, keep checking the tension on the drive cable until the desired tension is reached.

STEP 5



Tighten the lock nut finger tight, back towards the adjuster nut and check for drive on the lawn mower. Once drive is restored, tighten the lock nut securely.

Assembly

Adjusting Cutting Height

The P4600SP lawnmower has 6 cutting heights ranging from 25mm to 75mm.

To adjust the cutting height, pull the adjustment lever outwards and select the required height.

The height is automatically adjusted for all wheels.



For more information on what cutting height you should be using, go to page 39.

Before Each Use

- Always ensure that the mower is in a safe working condition. Inspect the blade, check safety devices and guards and check all nuts, bolts and screws are secure.
- Check the oil level, go to page 16 for instructions.
- Fill the fuel tank with unleaded petrol. Go to page 16 for instructions.
- Check the OPC cable, if there is more than 10mm movement in the OPC lever before the cable begins to move, then the OPC cable will require adjustment. Go to page 18 for instructions.

Starting The Lawnmower

Cold Start Procedure

 **NOTE** - You **MUST** ensure the mower has the correct oil and fuel level before operation.

STEP 1



Make sure the blade is free of long grass and the cutting height is set to maximum.

STEP 2



Pump the primer bulb 5 times.

STEP 3



Pull the Operator Presence Control (OPC) lever towards the main handle.

STEP 4



Gently pull the recoil start handle until you feel resistance.

STEP 5



Then pull the handle swiftly, until the lawn mower starts.

Starting The Lawnmower

Warm Start Procedure

STEP 1



Make sure the blade is free of long grass and the cutting height is set to maximum.

STEP 3



Gently pull the recoil start handle until you feel resistance.

STEP 2



Pull the Operator Presence Control (OPC) lever towards the main handle.

STEP 4



Then pull the handle swiftly, until the lawnmower starts.

Stopping The Lawnmower

After Each Use

- Examine the blade for damage.
- Clean the machine if necessary, go to page 35 for more information on how to clean your machine.

Stopping Procedure

⚠ CAUTION - The engine and exhaust will remain hot for a while after use. Ensure the engine and exhaust have cooled before carrying out any maintenance or storage.

Before stopping the machine, you must allow the engine to idle for 30 seconds.

STEP 1

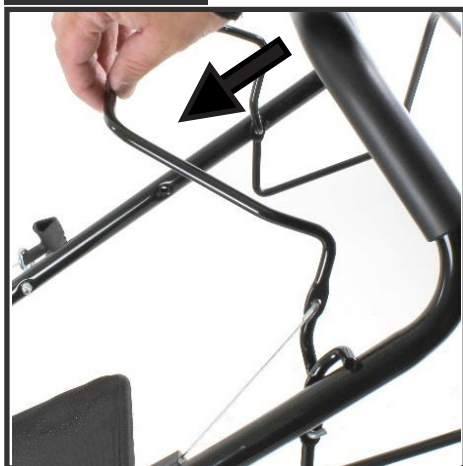

Before stopping the machine, you must allow the engine to idle for 30 seconds.

Release the OPC Lever and the engine will stop.

Specifications

Model	P4600SP
Engine Type	HYUNDAI OHV 4-Stroke
Engine Size	139cc
Fuel Tank Capacity	1L
Fuel Type	Straight Unleaded Petrol
Oil Capacity	600ml
Oil Type	SAE 30 or 15W40
Rated Speed	2800rpm
Rated Power	3.6kW
Drive Type	Self Propelled
Start Method	Recoil Start
Height Adjustment	Central
Cutting Height	25-75mm (6 Heights)
Cutting Width	460mm / 46cm
Grass Collector Type	Polyester Bag
Grass Collector Volume	60L
Deck Material	Treated Steel
Wheel Size Front	180mm
Wheel Size Rear	250mm
Measured Sound Level	95dB(A)
Guaranteed Sound Level	96dB(A)
Vibration Value	9.794m/s ² K=1.5 m/s ²
Handle Type	Soft Grip
Start Method	Recoil Start
Dimensions	770 x 565 x 440mm
Weight	33kg

NOTE - All machines are tested and inspected so there may be some residual oil left in the machine so please fill with caution.

Troubleshooting

NOTE - Where necessary, all corrective actions should be carried out by suitably qualified persons. If the starter rope becomes disconnected from the rope guide on handle, disconnect the spark plug cap. Pull the starter rope out from engine slowly and re-engage in guide. Re connect spark plug cap.

Problem	Possible Cause	Possible Corrective Action
Engine does not start	OPC cable not adjusted correctly	Adjust OPC cable
	Fuel tank is empty	Fill fuel tank
	Stale fuel	Drain carburetor float bowl
	Air filter element is dirty	Clean or replace air filter
	Spark plug is loose	Tighten spark plug
	Spark plug cap loose or disconnected	Correctly fit the sark plug cap
Spark plug faulty	Spark plug gap is incorrect	Set plug gap to 0.7-0.8mm or replace spark plug
	Carburetor is flooded with fuel	Remove the air filter and pull starter rope until carburetor clears
	Faulty ignition module	Contact the service dealer
Engine difficult to start or loses power	Dirt, water or stale fuel in tank	Drain fuel and clean tank. Fill with clean, fresh fuel
	Vent hole in fuel tank is clogged	Clean or replace fuel tank cap
	Air filter element is dirty	Clean or replace air filter element
Engine operates erratically	Spark plug is defective	Fit new, correctly gapped spark plug
	Spark plug gap is incorrect	Set plug to 0.7-0.8mm
	Air filter element is dirty	Clean or replace air filter element
Engine idles poorly	Air filter element is dirty	Clean or replace air filter element
	Air slots in engine are blocked	Remove debris from slots
	Cooling fins and air passages under engine housing are blocked	Remove debris from cooling fins and passages
Engine skips at high speed	Spark plug electrode gap is incorrect	Set plug to 0.7-0.8mm
Engine overheating	Cooling airflow is restricted	Remove any debris from slots in shroud, blower housing, air passages
	Incorrect spark plug	Fit new spark plug
Mower vibrates abnormally DO NOT use the machine until vibration issue has been fixed	Cutting assembly is loose	Tighten blade
	Blade/cutting assembly is unbalanced	Take to a service dealer

Maintenance & Care

Safety

 **1. WARNING** - Before cleaning or doing maintenance work, you need to disconnect the spark plug cable and read the relevant instructions. You need to wear proper clothing and protective gloves whenever your hands are at risk.

 **2. WARNING** - If there are worn or damaged parts, never use the machine. Faulty or worn-out parts must be replaced and not repaired. You must only use original spare parts. The use of non-original and/or incorrectly fitted parts will jeopardize the safety of the machine. This may also cause accidents or personal injuries for which the manufacturer is under no circumstance liable or responsible.

3. Any maintenance operations or adjustments not explained in this manual must be carried out by your Dealer or a specialised Service Centre with the necessary knowledge and equipment to ensure that the work is done correctly maintaining the lawnmower's original safety level. Any operations performed in unauthorised centres or by unqualified persons will invalidate the Warranty and all obligations and responsibilities of the Manufacturer.

4. Disconnect the spark plug cable and check for damage after each use.

5. To be sure the machine is in safe working condition, keep all nuts, screws and bolts tight. Routine maintenance is essential for safety and for maintaining a high performance level.

6. On a regular basis, check that the blades screws are properly tightened.

7. When handling, disassembling and re-assembling the blade, make sure to wear work gloves.

8. Keep the blade well balanced during

sharpening. All work on the blade (disassembly, sharpening, balancing, re-assembly and/or replacing) should be carried out at a specialised centre as they are demanding jobs that require special skills and special tools.

9. Be very careful during adjustment of the machine to prevent entrapment of the fingers between moving parts of the blade and fixed parts of the machine.

10. Do not touch the blade until the spark plug has been disconnected and the blade is completely stationary. When servicing the blade, even though the spark plug cable is disconnected, the cutting means can still move.

11. Check the side discharge guard, the rear discharge guard and the grass collector frequently. Replace them if they are damaged.

12. If any warning message stickers or instruction is damaged, replace them.

13. Store the machine in a safe place, out of the reach of children.

14. Do not store the machine with fuel in the tank in an area where the fuel vapours could reach an open flame, a strong heat source or a spark.

15. Engine must be cooled down before storing.

16. To reduce fire hazards, keep the engine, silencer, battery compartment and petrol storage area free of grass, leaves, or excessive grease. You must always empty the grass collector and do not leave containers full of cut grass inside storage areas.

17. To reduce fire hazards, check there is no oil and/or fuel leaks on a regular basis.

18. If you need to empty the fuel tank, this should be done outdoors once the engine has cooled down.

Maintenance & Care

Routine Maintenance

⚠️ IMPORTANT - Routine and accurate maintenance is essential for maintaining original machine safety and performance levels.

Always stop the engine and unplug the spark plug before doing any repairs or maintenance.

Only use original spare parts: The use of non-original and/or incorrectly fitted parts will jeopardize the safety of the machine, may cause accidents or personal injuries for which the Manufacturer is under no circumstance liable or responsible.

1. Wear strong protective gloves before cleaning, maintaining or making adjustments to the lawnmower.
2. You must remove grass and mud from the chassis to prevent it from drying. This will cause problems the next time the lawnmower is used. For more information on cleaning, go to page 35.
3. Paint on internal chassis parts may start to flake over time due to abrasive action of cut grass. If this happens, you should touch-up with rust-proof paint to prevent rusting that could corrode the metal. You can also use a light oil or silicone spray to prevent rust.
4. If you need to access the lower part of the lawnmower, you must tilt the lawnmower with the air filter facing up, following the relevant instructions, making sure that the machine is stable before performing any interventions. On side discharge models, remove the discharge chute (if installed).
5. Make sure not to drip petrol onto the plastic parts to prevent damaging them and remove all traces of spilled petrol immediately. The warranty will not cover damage to plastic parts caused by petrol.

6. Use the water hose attachment to clean the internal parts of the chassis (only certain models have this). To perform cleaning, connect garden hose, adjust the cutting height to maximum. Start the engine and engage the blade, standing behind the lawnmower handle.

7. It is highly recommended to change the engine oil every 100 hours or 12 months. This will ensure the machine will function properly over time. The oil can be discharged at a specialised servicing centre, or by using a syringe to suction the oil out through the filler spout, bearing in mind you may need to repeat the operation several times in order to completely empty the engine oil sump. Remember to re-fill with SAE 30 or 15W40 oil before using the machine again.

8. It is necessary as part of routine maintenance to adjust the OPC (Operator Presence Control) cable tension to ensure the lawnmower will start correctly. If there is more than 10mm movement in the OPC lever before the cable begins to move, then the OPC cable will require adjustment. See page 18 for more information on adjusting the OPC cable.

9. Lubricate the wheel bearings with a suitable lubricant.

⚠️ CAUTION - DO NOT use a hose pipe or pressure washer to clean the engine. Water can damage the engine or contaminate the fuel system.

How To Service Video:

Go to [youtube.com](https://www.youtube.com) and type in How to Service the P4600SP Petrol Lawn Mower.

YOU MUST read and understand the instruction manual first.

Maintenance & Care

Oil

Oil Type: SAE 30 or 15W40 Engine Oil

Oil Capacity: 600ml

The oil must be checked before every use.

We recommend doing an oil service at least once a year, more frequently during periods of heavy use.

1. Disconnect the spark plug HT lead cap and with the engine oil warm, not hot, remove the dipstick.
2. Gently tilt the machine to allow the oil to drain from the dipstick port into a suitable container.
3. Refill slowly with approx. 600ml of fresh SAE 30 or 15W40 engine oil to the upper level mark on the dipstick.
4. Stop occasionally to check the oil level.



5. Do not overfill.
6. If you do overfill, gently tilt the machine and allow the excess oil to drain from the dipstick port, in to a suitable container or use an oil syringe.
7. Refit the dipstick securely.

The Spark Plug

You **MUST** allow the engine to cool down before carrying out any maintenance.

Recommended spark plug: NGK BP6ES.

Spark Plug Gap: 0.7 ~ 0.8mm (0.28" ~ 0.32")

We recommend checking the spark plug after every 25 hours of use and replacing once a year.

Always replace with the same model spark plug as fitted.

STEP 1



Allow the engine to completely cool. Remove the spark plug HT lead cap to expose the spark plug like in the image below:



Maintenance & Care

STEP 2



Using a spark plug spanner, remove the spark plug.



STEP 3

Inspect and clean the spark plug electrode, making sure there is no damage to the insulator or electrode.

STEP 4

If there is any damage or wear to the spark plug, replace immediately.

STEP 5

Using a feeler gauge, check the spark plug gap. The plug gap should be 0.70mm to 0.80mm, carefully adjust the plug gap by bending the side electrode.

0.028" to 0.031"
0.70mm to 0.80mm

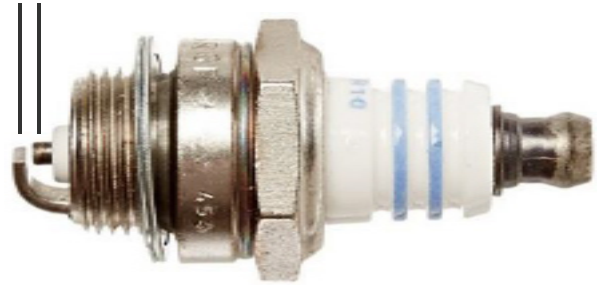

STEP 7

Refit the cleaned and adjusted spark plug by hand to avoid cross-threading.

STEP 8

Once the spark plug seats, tighten with the spark plug spanner DO NOT over tighten.

STEP 9

Replace the spark plug HT lead cap.

Maintenance & Care

Air Filter

⚠ CAUTION - A dirty air filter will restrict the air flow to the carburetor, which will reduce engine efficiency.

When using the lawnmower in very dusty areas you must clean or replace the air filter more often.

Never operate the machine without the air filter being fitted it can cause damage to the engine which is not covered by warranty.

We recommend checking the air after every 25 hours of use and replacing once a year.

STEP 1



Allow the engine to completely cool and disconnect the spark plug HT lead cap. Push down the latch tabs on the side of the air filter box to reveal the air filter (as seen below).



STEP 2



Remove the air filter and ensure no dirt or debris can enter the carburetor chamber.

STEP 3

If a paper air filter is fitted, inspect and replace if necessary. Otherwise gently blow compressed air, not exceeding 30psi, through the filter from the reverse side to remove the majority of dirt and debris and reinstall.

If a foam filter is installed, inspect and replace if necessary. Otherwise, wash the air filter in a warm soap solution, rinse and allow to dry.

Once dry, soak the foam filter in fresh engine oil and allow the excess to drain off.

Reinstall the air filter and close the air filter cover.

Maintenance & Care

Blade Maintenance

⚠ CAUTION - ALWAYS handle the lawn mower blade wearing thick gloves suitable for purpose. Lawn mower blades can be sharp and cause personal injury if handled incorrectly.

Check the blade, in order to obtain a good cut, the blade should always be sharp and well balanced. At regular intervals, check the tightness of all nuts, bolts and screws. If the blade hits an obstacle check for damage and if the machine vibrates badly stop the lawnmower and take it to a service dealer.

It is best if all interventions on the blade are done at a specialised centre that has the special tools and equipment.

Only original blades must be used on this machine. Given product evolution, the blades may be replaced in time with others having similar interchangeable and operating safety features.

- You **MUST** wear gloves to protect your hands from being cut when working with the blade.
- The blade is made of pressed steel, in order to obtain a good cut, sharpen the blade frequently, typically around every 25 hours of work.
- Following blade sharpening you must make sure that the blade is always well balanced.
- To remove the blade, unscrew the bolt, check the blade carrier and all components, replace if they are worn or damaged.

To inspect or remove the blade it is advisable to drain all the fluids from the mower and disconnect the spark plug HT lead cap before inspecting.

STEP 1



Turn the lawn mower on to its side making sure the side the air filter is installed on, is facing up.

STEP 2



Using suitable gloves, firmly hold the blade and undo the centre bolt in an anti-clockwise direction.

NOTE: this may be stiff as the bolt needs to be installed tightly.

Maintenance & Care

STEP 3



Remove the blade.

With the blade removed, inspect for straightness, damage and wear. Replace the blade if it shows signs of any of these, otherwise have the blade sharpened and balanced.

STEP 4

Reinstall the blade securely by reversing the procedure above.

Drive Belt

⚠ CAUTION - ALWAYS handle the lawn mower blade wearing thick gloves suitable for purpose. Lawn mower blades can be sharp and cause personal injury if handled incorrectly.

We recommend inspecting the drive belt as part of an annual inspection. More frequently during periods of heavy use.

If drive has been lost, check the cable adjustment first as set out on page 31-32 before inspecting the belt.

STEP 1

Remove the blade as shown on pages 31-32.

STEP 2

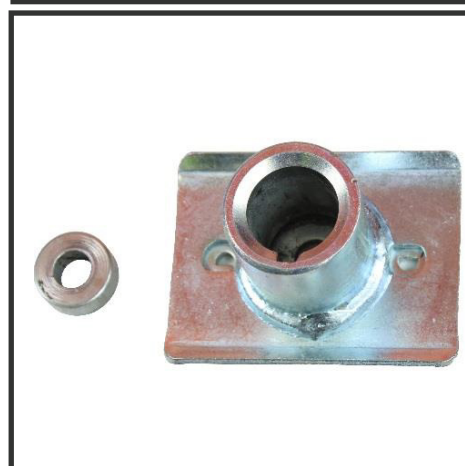

Remove the drive coupling and spacer.

Maintenance & Care



Be careful not to lose the keyway attached to the drive shaft.

STEP 3



Remove the plastic drive belt guard by undoing the 2 bolts and screw holding it in place, to expose the drive belt:



STEP 4



Inspect the belt for wear or damage and check tension. There should be no more than 10mm free play when gently checking tension.

If the belt is damaged or worn, replace immediately.

STEP 5

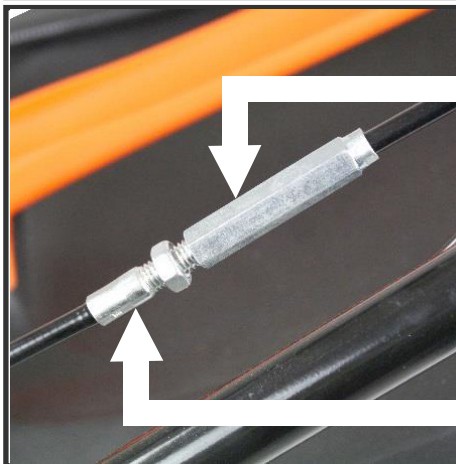

Adjuster

Lock Nut

Loosen the tension on the drive belt by undoing the lock nut on the drive cable.

Maintenance & Care

STEP 6



Unhook the belt from the main drive pulley.

STEP 7



Unhook the belt from the rear pulley.

STEP 8



The belt should now be free to remove completely.

STEP 9

To reinstall, reverse the procedure above.

Maintenance & Care

Fuel And Carburetor

⚠ CAUTION - ALL FUELS ARE FLAMMABLE

ALWAYS fuel and defuel in a well ventilated area outside of buildings.

ALWAYS wear correct, suitable and fit for purpose Personal Protective Equipment (PPE), suggested items are but not limited to safety gloves, overalls.

- The use of old or stale fuel will impair starting and running of the machine.
- Make sure that the machine has fresh unleaded fuel and always remove fuel before storing for long periods.
- Never mix fuel and oil.

Draining The Carburetor Float Bowl

1. To drain fuel from the float bowl of the carburetor, drain all the fuel from the fuel tank. Locate the carburetor float bowl at the front of the lawn mower.
2. Place a suitable container underneath the float bowl and unscrew the drain screw located on the angled side of the float bowl. Take care not to lose the washer on the drain screw.
3. Allow all the fuel to drain before reinstalling the drain plug screw.

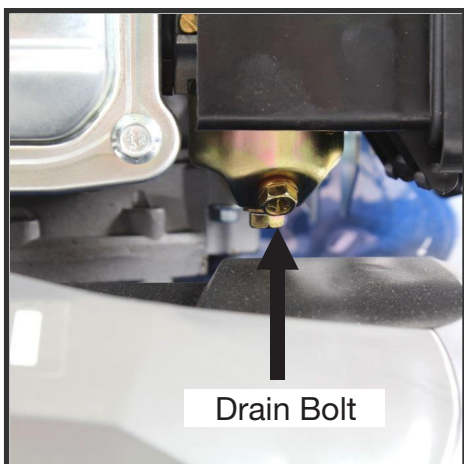

Cleaning

⚠ CAUTION - DO NOT use a hose pipe or pressure washer to clean the engine. Water can damage the engine or contaminate the fuel system.

- Wipe the deck with a dry cloth.
- You can hose under deck by tilting the mower. Make sure you tilt the machine so that the air filter is facing up.

NOTE Engine must be switched off and plug lead disconnected.

- You must remove grass and mud from inside the deck to prevent it from drying. This will cause problems the next time the lawnmower is used.
- Dry the machine completely to prevent any rust forming. You can use a light oil or silicone spray to prevent rust.
- Avoid using solvents when cleaning plastic parts. Most plastics are susceptible to damage from various types of commercial solvents and may be damaged by their use.
- Pores in the grass collector can become filled with dirt and dust during use and will collect less grass. To prevent this, regularly hose the collector off with water and let to dry before using.

Maintenance & Care

Storage

 **CAUTION** - When storing the machine, make sure it has been cleaned as in the section above. You can use a light oil or silicone spray to coat the equipment.

NOTE - If storing the lawn mower for a period of 30 days or more, you must follow proper storage and winterisation guidelines to avoid any possible issues with your lawn mower. Incorrect storage can lead to possible fueling or engine issues that will not be covered by the warranty.

The following steps should be taken to prepare your lawnmower for storage.

1. Drain all the fuel from the fuel tank and then run the lawn mower until it has completely run out of fuel to clear the remaining fuel from the fuel lines and carburetor.
2. Drain the oil from the engine as set out on page 16.
3. With the lawn mower drained of all fluids, follow the cleaning instructions as set out on page 35.
4. Follow the maintenance section and check, service or replace serviceable items if required. Check the blade to make sure that it is ready for the following season – This will allow you to get it sharpened correctly. Use a light oil or silicone spray to help prevent the blade from rusting.
5. Using a silicone spray grease, lightly coat the lawn mower blade to prevent possible rusting during storage.
6. Using a silicone spray grease, lightly grease all moving parts on the lawn mower.
7. Drain engine oil and replace with new SAE 30 or 15W40 engine oil, fill to the upper mark on the dipstick.

8. Remove the spark plug and pour 1 teaspoon of fresh engine oil down the cylinder bore. Cover the spark plug hole with a lint free clean cloth, ensuring no dirt or debris falls into the cylinder chamber and gently pull the recoil starter handle to coat the cylinder bore with the fresh oil.

9. Refit the spark plug.

10. Once all work above is carried out store the machine in a clean, cool and dry place away from sources of ignition and varying changes in temperature. **DO NOT** store a machine that has not been given time to fully cool down.

11. The handle can be folded down to save space during storage. Be careful not to trap any of the operating cables when folding or unfolding the handle. Do not stack anything on top of the lawn mower.

Transportation And Handling

1. Whenever the machine is to be handled, lifted, transported or tilted you must:

- Wear sturdy work gloves
- Hold the machine at the points that offer a safe grip, taking into account the weight and relative distribution of the same
- Use an appropriate number of people for the weight of the machine and the characteristics of the vehicle or the place where it must be placed or collected
- You must make sure that machine movements do not cause petrol leaks, damage or injuries.

2. During transport, make sure to fasten the machine securely with cables or chains.

Maintenance & Care

Environmental Protection

1. Environmental protection should be a priority of considerable importance when using the machine, for the benefit of both social coexistence and the environment in which we live. Try not to cause any disturbance to the surrounding area.
2. You must comply with local regulations and provisions for the disposal of packaging, oils, petrol, filters, damaged parts or any elements which have a strong impact on the environment. This waste must not be disposed of as normal waste. It needs to be separated and taken to specified waste disposal centres where the material will be recycled.
3. You must comply with local regulations for the disposal of waste materials after mowing.
4. When disposing, do not pollute the environment with the machine, but hand it over to a disposal centre, in accordance with the local laws in force.

Recycling And Disposal



We do not offer a takeback scheme for the recovery of Waste Electrical Electronic Equipment (WEEE) & Batteries. Instead the responsibility to dispose of WEEE and or Batteries is passed onto you by us.

So when it becomes necessary to dispose of your machine you must take it to your local Civic Amenity Site. For further information please contact your local Authority for disposal advice.

You **MUST** make sure that all unused oil and fuel is disposed of correctly either beforehand

or at your local Civic Amenity Site.

Under NO circumstances must any fuel or oil be put down any drains.

Certain products contain WEEE waste which should not be disposed of in your domestic waste.

You **MUST** recycle WEEE in accordance with your local authority or recycling centre.

Certain products contain batteries which should not be disposed of in your domestic waste.

You **MUST** recycle batteries in accordance with your local authority or recycling centre.

Unwanted packaging and materials should be stored and taken to a recycling centre so it can be disposed of in a manner which is compatible with the environment.

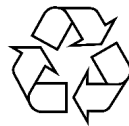

This symbol means you should 'Reduce - Reuse - Recycle'

We are a Member of the VALPAK National Compliance Scheme and our registration number is **RM08660**

For further information about disposal please contact your Local Authority.

You can also get more advice and guidance about recycling at the following website <http://www.recycle-more.co.uk>

Should you pass this product on to another user either sold or loaned, you **MUST** pass on this user manual. This will make sure that all other users can use and maintain this machine safely.

Spare Parts

Only use original spare parts: The use of non-original and/or incorrectly fitted parts will jeopardize the safety of the machine, may cause accidents or personal injuries for which the Manufacturer is under no circumstance liable or responsible.

Part	Part Number
Blade	P4600SPBLADE
Cable	P4600SPCABLE
Recoil Start	P4600SPRECOIL
Wheel	P4600SPWHEEL
Grass Collector	P4600SPGRASSCOLLECTOR
Spark Plug	P4600SPSPARKPLUG
Engine Oil SAE 30 or 15w40	600MLSAE30OIL

Tips For Mowing

General Tips

- Maintain a constant cutting height of 3-5cm. Do not shorten the grass to less than half its original height.
- Under certain conditions, such as very tall grass, it may be necessary to raise the height of cut to reduce pushing effort, prevent overloading of the motor and leaving clumps of grass clippings.
- It may also be necessary to reduce ground speed and/or push the lawnmower over the area a second time. For extremely heavy cutting, reduce the width of cut by overlapping the previously cut path and mow slowly.

How Often Should I Mow?

Spring (March, April & May)

Mow once a week on a high to medium height setting.

Summer (June, July & August)

Mow twice a week under good growing conditions on a low setting. In dry conditions, mow once a week on a medium to high height setting.

Autumn (September, October & November)

Mow once a week on a medium height setting.

Winter (December, January & February)

Mow as required on a high setting.

What Time Should I Mow?



Early Morning (6am-8am)

Grass could be wet and your lawnmower could leave tracks.



Mid Morning (8am-12pm)

Optimal time to mow - before the heat of the day.



Mid Day (1pm-4pm)

It is fine to mow your lawn in the middle of the day but it is not optimal.



Late Afternoon (4pm-6pm)

A great time to mow your lawn. The temperature will be cooler causing less stress for your lawn.



Early Evening (6pm-8pm)

This is not optimal time because your lawn needs time to recover before nightfall.

Useful Information

Check Out Our YouTube Channel

Our videos on YouTube include:

- Unboxing
- Assembly of your machine
- How to service your machine
- 'How To' videos
- Product features

Search 'P1PE' in YouTube to find our channel.

Warranty

Register your 2 year warranty within 30 days of purchase at:
p1pe.co.uk/warranty

Full warranty terms and conditions can be found on the P1 Power Equipment website:
www.p1pe.co.uk

Manual Updates

Our manuals are constantly being reviewed and updated. Should you find an error, omission or something unclear, please contact us for assistance.

We reserve the right to make any modifications without prior notice whenever necessary.

Returning Your Product

If you are returning your product, please contact the dealer for their returns policy.

Leaving A Review

We work very hard to give all of our customers the best possible service.

If you have any problems, before leaving negative feedback, please contact us to give us a chance to resolve the issue.

We would be delighted if you left us positive feedback!

Ordering Spare Parts

Only use original spare parts: The use of non-original and/or incorrectly fitted parts will jeopardize the safety of the machine, may cause accidents or personal injuries for which the Manufacturer is under no circumstance liable or responsible.

Go to page 38 for part numbers.

Need Help? Talk To Our Experts

Contact Us

Our friendly aftersales team will be more than happy to help you.

Phone

Call our team on 01646 687880, open Monday-Friday 8.30am-5pm.

Online Live Chat

Go to www.p1pe.co.uk

Live chat is open Monday-Friday from 8.30am-5pm.

Post

Genpower Limited, Isaac Way, Pembroke Dock, Pembrokeshire, SA72 4RW, UK.

As soon as you have purchased the machine, we recommend that you fill out the following. If you need to contact an authorised dealer or customer service for information on servicing, you may need to provide the following information.

The model number and serial number can be found on the grey specification sticker on the lawnmower deck.

Date Of Purchase:

Dealer Name:.....

Dealer Phone:.....

Model Number:.....

Serial Number:.....

Service Record

1st Service

Date Of Service.....

Next Service Due.....

2nd Service

Date Of Service.....

Next Service Due.....

3rd Service

Date Of Service.....

Next Service Due.....

4th Service

Date Of Service.....

Next Service Due.....

Declaration Of Conformity

EC Declaration of Conformity

We hereby declare that the machine detailed in this declaration complies to all the relevant provisions of the following EC directives.

- 2006/42/EC The Machinery Directive
- 2014/30/EU Annex II Electromagnetic Compatibility Directive
- 2016/1628/EC The Emission of Gaseous and Particulate Pollutants from internal Combustion engines
- 2000/14/EC Noise Emissions in the Environment by Equipment for use Outdoors.

And is in conformity with the applicable requirements of the following documents:

- EN ISO 3744:2010
- EN ISO 11094:1991
- EN ISO 5395-1:2013
- EN ISO 5395-2: 2013
- EN ISO 14982:2009

Notified Body: TÜV SUD Shanghai Branch.

Model	Type	Cutting Width	Measured Sound Power	Guaranteed Sound Power	Engine Speed (rpm)
P4600SP P5100SPE	Petrol lawn mower	460mm 508mm	95dB(A) 97dB(A)	96dB(A) 98dB(A)	2800 2800

Product Details

Brand: P1, powered by Hyundai IC140V and IC200VE engines.

Model: P4600SP, P5100SPE

Description: Petrol lawnmower

Name and address of technical documentation holder and EU distributor:

Genpower Ltd, Isaac Way, Pembroke Dock, Pembrokeshire, SA72 4RW, UK.

Signed by: 

Roland Llewellyn, Managing Director

Date: 10/12/2019

Importer:
GENPOWER LTD
Isaac Way, London Road,
Pembroke Dock, UNITED KINGDOM, SA72 4RW
T: +44 (0) 1646 687 880 F: +44 (0) 1646 686 198
www.p1pe.co.uk

Imported/Distributed by Genpower Ltd for The United Kingdom & Ireland